



JICTECH LCD (HONGKONG) CO.,LTD
DONGGUAN JICTECH LCD CO.,LTD
PROFESSIONAL LCM SUPPLIER

PRODUCT SPECIFICATION FOR LCD MODULE

Model NO.:RSH043I5BSC-12

Specification Ver.: 01

APPROVAL FOR SPECIFICATIONS ONLY

APPROVAL FOR SPECIFICATIONS AND SAMPLE

CUSTOMER :

APPROVED BY :

JICTECH LCM R&D CENTER

APPROVED BY

CHECKED BY

PREPARED BY

LGF

LGF

LGF

REVISION RECORD



1. GENERAL SPECIFICATION	4
2. OUTLINE DIMENSIONS	6
3. ABSOLUTE MAXIMUM RATINGS	7
4. ELECTRICAL CHARACTERISTICS	7
5. INTERFACE DESCRIPTION	8
6. OPTICAL CHARACTERISTICS	9
7. RELIABILITY TEST CONDITIONS	11
8. INSPECTION CRITERIA	14
9. PRECAUTION FOR USE OF LCD MODULE	28
9.1. HANDLING PRECAUTIONS	28
9.2. ASSEMBLING PRECAUTIONS	29
9.3. STORAGE PRECAUTIONS	29
9.4. DESIGN PRECAUTIONS	29

1. GENERAL SPECIFICATION

1.1 Introduction

The **RSH043I5BSC-12** is a color active matrix Thin Film Transistor (TFT) Liquid Crystal Display (LCD) that uses amorphous silicon (a-Si) TFT as a switching device. This model is composed of a single **4.3** inches transmissive type main TFT-LCD panel. The resolution of the panel is **800[RGB]x480** pixels and can display up to **16.7M** color.

1.2 Feature

- Using **IPS** panel. Ultra wide Angle of view.
- FOG and backlight assembly module.
- 24 BIT RGB interface.

1.3 Application

- Display terminals for digital products. Industrial control Etc.

1.4 General Specification

No.	Item	Specification	Note
1	LCD Size	4.3 inch	-
2	Panel Type	a-Si TFT active matrix	-
3	Resolution	800RGB(H) x 480(V) pixel	-
4	Display Mode	IPS/ Normally Black	-
5	Display Number of Colors	16.7M colors	-
6	Viewing Direction Gray inversion/Eye:	Free	-
7	Contrast Ratio	800	-
8	Luminance	850cd/m ²	-
9	Module Size	105.50mm(H)x67.15mm(V)x4.6mm(T)	-
10	Active Area	95.04mm(H) x 53.86mm(V)	-
11	Pixel Pitch	0.1188mm(H) × RGB × 0.1122mm(V)	-
12	Driver IC	ST7262	-
13	CTP Driver IC	FT5446	-
14	Light Source	12 LEDs White	-
15	Interface	24 BIT RGB	-
16	Operating Temperature	-20~70 (Max. scope)	-
17	Storage Temperature	-30~80 (Max. scope)	-
18	Total Power dissipation	VCC=3.3V	-
19	Weight	TBD g	-

2. OUTLINE DIMENSIONS

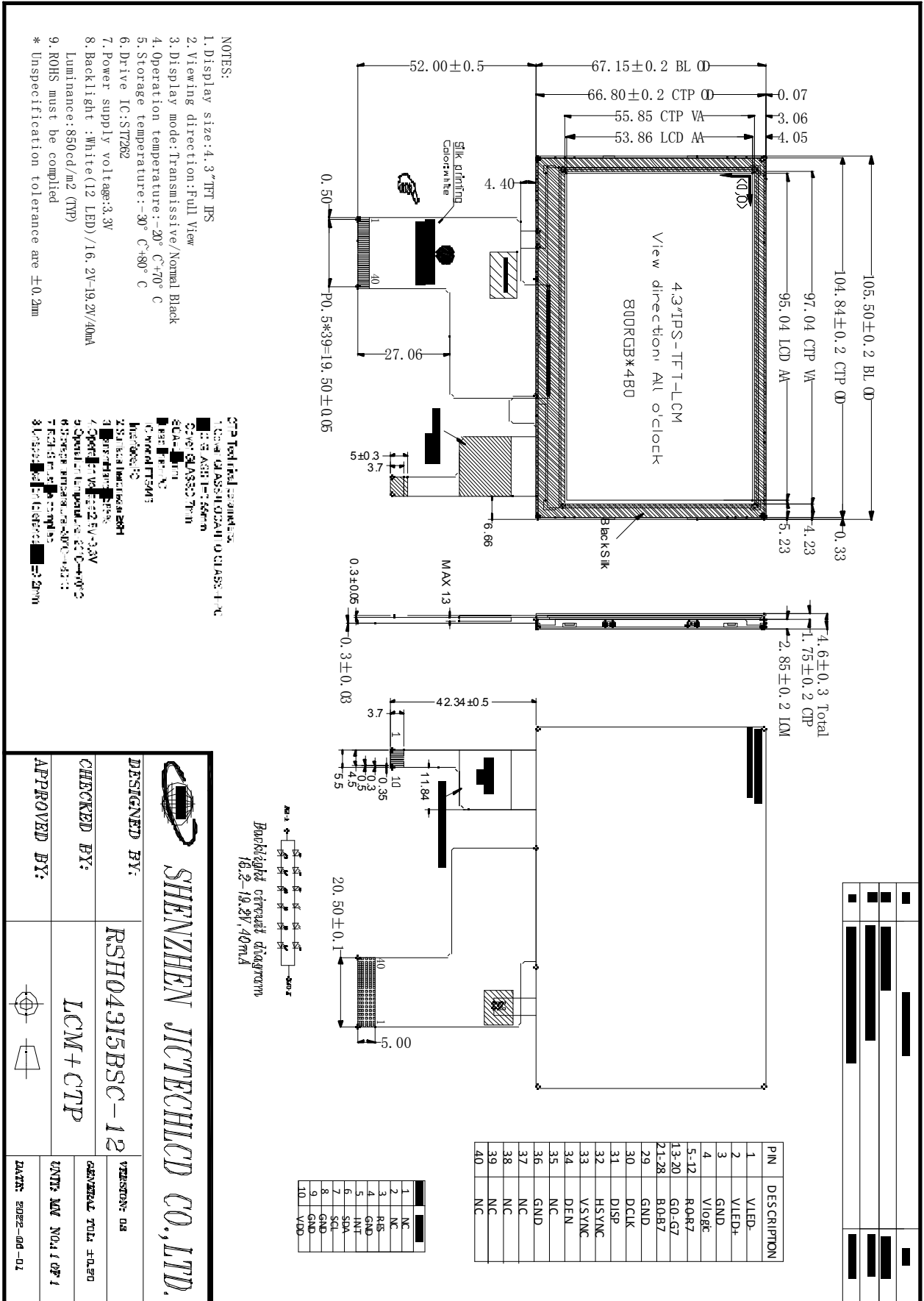

3. ABSOLUTE MAXIMUM RATINGS

Parameter of absolute maximum ratings	Symbol	Min	Max	Unit
Supply voltage	VCI-VSS	-0.3	+4.6	V
Supply voltage for I/O	IOVCC-VSS	-0.3	+4.6	V
Input voltage	Vin	-0.3	IOVCC+0.3	V
Operating temperature	Top	-20	70	°C
Storage temperature	Tst	-30	80	°C
Humidity	RH	-	90%(Max60 °C)	RH

4. ELECTRICAL CHARACTERISTICS

4.1. DC Characteristics for Panel Driving

Item	Symbol	Min	Typ	Max	Unit
Supply voltage for logic	VDD	2.8	3.3	3.6	V
Input Current	Idd	-	TBD	-	mA
Input voltage 'H' level	VIH	0.7VDD	-	VDD	V
Input voltage 'L' level	VIL	VSS	-	0.3VDD	V
Output voltage 'H' level	VOH	VDD-0.4	-	VDD	V
Output voltage 'L' level	VOL	VSS	-	VSS+0.4	V

4.2. Backlight Characteristics

Item	Symbol	Min.	Typ.	Max.	Unit	Condition
Forward voltage	V	16.8	18.0	21.0	V	If=40mA
LED circuit	6 LEDs serial connection & 2 parallel					
Chromaticity White CIE (x, y)	x	0.25	-	0.35	-	If=40mA
	y	0.25	-	0.35	-	

Using condition: constant current driving method $I_f = \text{Single led } 20\text{mA}(\pm 10\%)$.

5. INTERFACE DESCRIPTION

5.1. LCM PORT:

Pin No.	Symbol	I/O	Description	When not in use
1	VLED-	P	Cathode power supply for backlight	
2	VLED+	P	Anode power supply for backlight.	
3	GND	P	Power ground	
4	Vlogic	P	Power supply	
5~12	R0~R7	I	Red Data.	
13~20	G0~G7	I	Green Data.	
21~28	B0~B7	I	Blue Data.	
29	GND	P	Power ground	
30	DCLK	I	Clock signal	
31	DISP	I	Display control/Standby mode selection. DISP = "Low" :Standby. DISP = "High" :Normal display.	
32	HSYNC	I	Horizontal Sync Input	
33	VSYNC	I	Vertical sync signal	
34	DEN	I	Data input enable	
35	NC	-	No Connector.	
36	GND	P	Power ground	
37	NC	-	No Connector.	
38	NC	-	No Connector.	
39	NC	-	No Connector.	

40	NC	-	No Connector.	
----	----	---	---------------	--

Note: The voltage power of the interface logic pin depend on “IOVCC” and “GND”.

5.2. CPT PORT:

Pin No.	Symbol	I/O	Description	When not in use
1	NC	-		
2	NC	-		
3	RES	I	External Reset,Low is active	
4	GND	P	Power ground	
5	INT	I	Interrupt request to the host,or Wakeup request from the host	
6	SDA	I/O	I2C data input and output	
7	SCL	I	I2C clock input	
8	GND	P	Power ground	
9	GND	P	Power ground	
10	VDD (3.3V)	P	Power supply	

6. OPTICAL CHARACTERISTICS

Item	Symbol		Condition	Min	Typ	Max	Unit	Remark
Contrast ratio	CR		Viewing normal angle $\theta=\psi=0^\circ$ If=40mA TC=25°C	-	800	-	-	Note 1
White Luminance (center)	Lv			700	850	-	cd/m ²	Note 2
Brightness uniformity	δ WHITE			80	-	-	%	Note 3
Response time	Tr+Tf			-	-	-	ms	Note 4
Color Chromaticity (CIE1931) (center)	White	Wx					-	-
	White	Wy				-	-	
Viewing angle range	θ	3:00	Center (CR≥10)	70	80	-	degree	Note 5
		9:00		70	80	-		
		6:00		70	80	-		

		12:00		70	80	-		
NTSC Ratio		S	-	-	70%	-	-	Note6

*Note: All above side data are based on JICTECH following condition.

Note1. Contrast Ratio (CR) is defined mathematically by the following formula. For more information see FIG 1.

$$\text{Contrast Ratio} = \frac{\text{Average Surface Luminance with all white pixels}}{\text{Average Surface Luminance with all black pixels}}$$

Note2. Surface luminance is the LCD surface from the surface with all pixels displaying white. For more information see FIG 1.

$$L_v = \text{Average Surface Luminance with all white pixels (P1, P2, P3, P4, P5)}$$

Note3. The uniformity in surface luminance (δ WHITE) is determined by measuring luminance at each test position 1 through 5, and then dividing the maximum luminance of 5 points luminance by minimum luminance of 5 points luminance. For more information see FIG 1.

s

$$\delta \text{ WHITE} = \frac{\text{Minimum Surface Luminance with all white pixels}}{\text{Maximum Surface Luminance with all white pixels}}$$

Note4. Response time is the time required for the display to transition from White to black (Rise Time, T_r) and from black to white (Decay Time, T_f). For additional information see FIG 2.

Note5. Viewing angle is the angle at which the contrast ratio is greater than 2. For TFT module the contrast ratio is greater than 10. The angles are determined for the horizontal or x axis and the vertical or y axis with respect to the z axis which is normal to the LCD surface. For more information see FIG 3.

Note6: NTSC ratio : For more information see FIG 4.

$$\text{NTSC ratio} = \frac{\text{Area of RGB triangle}}{\text{Area of NTSC triangle}}$$

FIG.1. Measuring method for Contrast ratio, surface luminance, Luminance

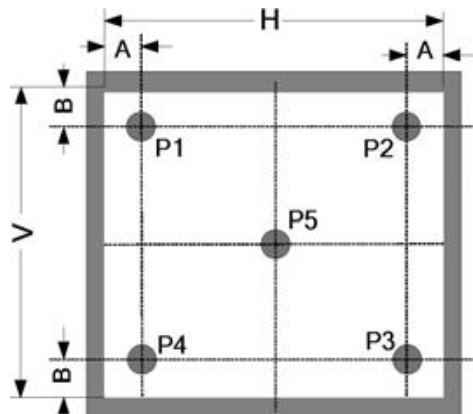

s

A : 5 mm

B : 5 mm

H,V : Active Area

Light spot size =5mm, 500mm distance from the LCD surface to detector lens

measurement instrument is luminance meter BM-7.

or DMS 803.

FIG.2.The definition of Response Time

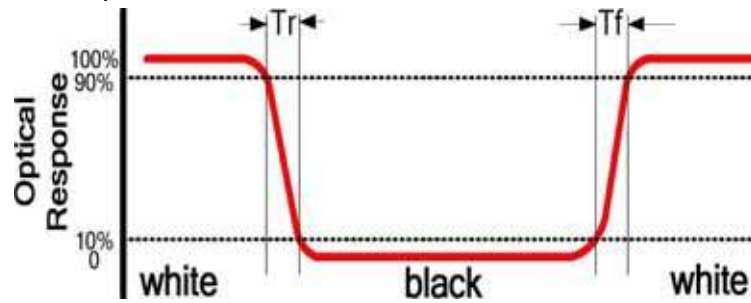

FIG.3. The definition of viewing angle

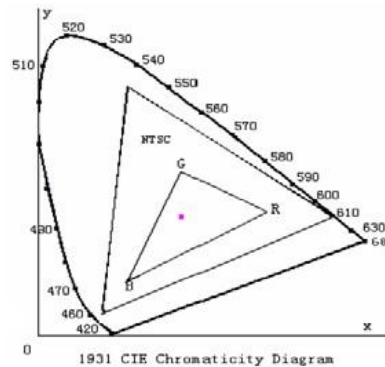
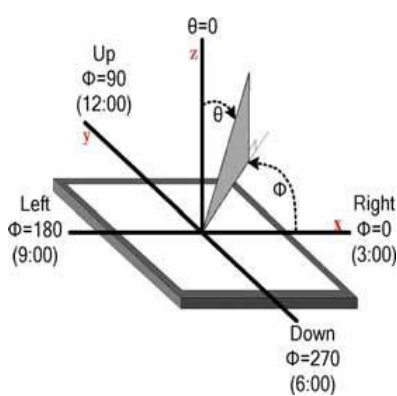

Fig.4. 1931 CIE chromaticity diagram

7.RELIABILITY TEST CONDITONS

No.	Test Item	Content of Test	Test Conditions
1	High Temperature Storage	Endurance test of high temperature for a long time.	$80\pm 2^{\circ}\text{C}48\text{H}$
2	Low Temperature Storage	Endurance test of low temperature for a long time.	$-30\pm 2^{\circ}\text{C}48\text{H}$
3	High Temperature Operation	Endurance test of electrical stress (Voltage & Current) and the thermal stress to the element.	$70\pm 2^{\circ}\text{C}48\text{H}$
4	Low Temperature Operation	Endurance test of electrical stress (Voltage & Current) and the thermal stress to the element.	$-20\pm 2^{\circ}\text{C}48\text{H}$



5	Thermal shock	Endurance test of low and high temperature cycles.(air to air)	-20±2°C(30min)→+25±2°C(30min)→+70(30min)±2°C,10 cycl
6	ESD test	ESD test	Voltage:±6kv/±4kv R: 200Ω C: 150pF Air/Contact discharge, 5 points each 1 times

Note:

- 1) When making the low temperature test, not to dewy.
- 2) Driving condition for operation test. Power Supply Voltage for Logic System Failure Judgment Criterion After the above mentioned test.(For Environmental Test, after 2 hours in room temperature.) There should not be conspicuous failure of display quality and appearance.
- 3) Contrast ratio should be 50% of the initial contrast ratio.
- 4) There should not have any abnormality of function.

LIFE TIME

Item	Description
1.	Functions, Performance, appearance, etc. shall be free from remarkable deterioration within 20,000 hours under ordinary operating and storage conditions room temperature ($25\pm 10^{\circ}\text{C}$) , normal humidity($40\pm 20\%\text{RH}$),and in area not exposed to direct sun light.

8.INSPECTION CRITERIA

1. The sampling plan and scheme
MIL-STD-105E,General II level standard single sampling inspection level
2. Acceptable standards (AQL)
main defects(MAJ) : 0.65
minor defects(MIN) : 1.5
3. Test conditions and method

Temperature $25\text{ }^{\circ}\text{C} \pm 5\text{ }^{\circ}\text{C}$,humidity $45\pm 20\%$,enough light (40W fluorescent lamp, about 40cm),the sight distance is 30cm
 $0^{\circ}\sim 45^{\circ}$ left and right 45° , upper and bottom $0^{\circ}\sim 45^{\circ}$

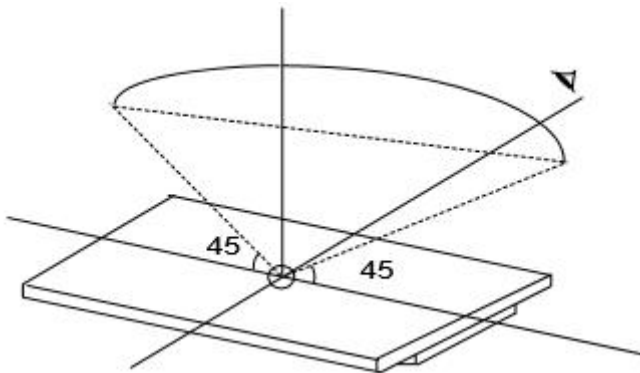

Area definition

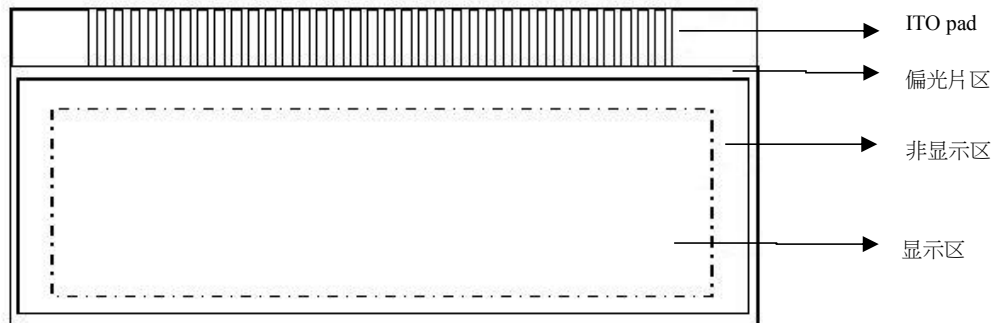

Intensive definition: there are less than two points or two lines within 10mm^2 , known as dense.

If the standards, specifications is not consistent with technical requirements, the product data sheet shall be prevailed

8.1 Classification of defects

The main defects (MAJ): the product has lost its function or can't reach the specification requirements in terms of performance parameters, or because of the size of the problem caused by the inability to assemble.

Slight defects (MIN): appearance can't meet the standard requirements, but no other effects

8.1 Test voltage, refer the usage requirements of jig set and the product design requirements, compare with approval sample

8.1.1 By default, LCD voltage external can be adjusted, the standard performance and voltage are controlled as below: when LCD driver voltage $\leq 5\text{V}$,controlled as $\pm 0.2\text{V}$,when LCD driver voltage $> 5\text{V}$,controlled as $\pm 0.3\text{V}$,for COG type, if the VOP is lower than 10V,controlled as $\pm 0.2\text{V}$,if VOP is higher than 10V,controlled $\pm 0.3\text{V}$.

8.1.2 Customers have special requirements for fixed voltage products, the internal circuit adjustment to ensure that the display effect, and if necessary, develop a lower limit of the sample

8.2 Defect items and acceptance standards

Mechanical size: to meet technical specifications drawings, according to the main defect judgment

Electrical properties

NO.	Items	Description	Acceptance criteria	Defect grade
8.2.1	Missing segment	Horizontal / vertical missing segment, lack of icons, lack of stroke	NG	MAJ
8.2.2	No display, no action	No display in normal connection	NG	MAJ
8.2.3	Display error, abnormal display	According to the normal scanning program, the ICON is inconsistent with order and requirements or displayed randomly	NG	MAJ
8.2.4	Wrong angle view	The angle view is inconsistent with the design requirements (or samples)	NG	MAJ
8.2.5	Contrast depth	Under normal display, the overall contrast is too deep or slight, and the voltage deviation exceeds the standard	Item voltage standard control	MAJ
8.2.6	Cross Talk	Display crosstalk shall not exceed limit sample	Reference limit sample	MAJ
8.2.7	Extra display	Display icons, strokes, rows, columns, lines, etc. that should not be displayed at work	Reference dot and line standard	MIN
8.2.8	PI dot	Local black spots or white spots appear when change image	Pause screen visible, reference point, line standard, reference sample during changing image	MIN

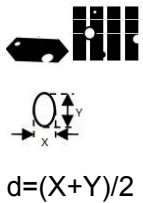
NO.	Items	Description	Acceptance criteria	Defect grade
8.2.9	Pinhole and bumps defect  $d=(X+Y)/2$	At work, the pattern is incomplete or out of shape	Reference dot and line standard	MIN

LCD appearance

Dot, line (just for V.A area control)

8.2.10

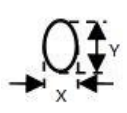
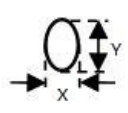
Item	size(mm)	QTY'			Defect grade
		Under 5"	5"~7"	7"~10.1"	
Spot (black dot, sundries,stab, sscratch)  $d=(X+Y)/2$	$d \leq 0.15$	2	3	3	MIN
	$d \leq 0.20$	1	3	3	
	$0.20 < d \leq 0.25$	0	1	2	
	$0.25 < d \leq 0.30$	0	0	1	
	$0.30 < d$	0	0	0	
Polarizer bubble  $d=(X+Y)/2$	$d \leq 0.15$	2	3	3	MIN
	$0.20 < d \leq 0.30$	1	2	2	
	$0.30 < d \leq 0.50$	0	0	1	
	$0.80 < d$	0	0	0	
Line (black line, white line,debris, stab, scratches, water wave)	$L \leq 2.00, W \leq 0.02$	1	2	3	MIN
	$L \leq 2.00, W \leq 0.03$	1	2	3	
	$L \leq 3.00, W \leq 0.05$	0	0	1	
	$L \leq 3.00, W \leq 0.10$	0	0	0	

LCD broken and crack, (aim at the product that without bezel and the LCD corner directly exposed including COG, heat seal connector (FPC),LCD+BL type, and the product with bezel ,if it won't affect the function and reliability after assembly or the breakage and crack covered by bezel ,it can be acceptable, L is the length of the breakage side, W is the width of ITO,T is the thickness for single LCD , H is the width together with plastic frame)

8.2.11

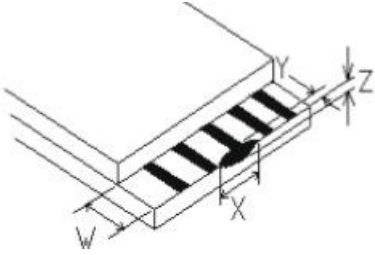
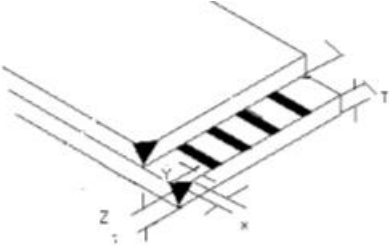
Item	Acceptable criteria				Defect grade	
Conductive foot position crack 	(mm)	Under 5"	5"~7"	7"~10.1"	MIN	
	X	≤ 3.0	$\leq 1/8L$	$\leq 1/6L$		
	Y	$\leq 1/4W$	$\leq 1/4W$	$\leq 1/3W$		
	Z	$\leq 1/2t$	$\leq t$	$\leq t$		
	acceptable QTY'	1	2	2		
When $Y \leq 0.2\text{mm}$, X length can be ignored, when non conductive surface cracked and not thoroughly crack, according to $X \leq 1/8L$, $Y \leq 1/2W$ or $X \leq 3\text{mm}$, $Y \leq W$						
corner crack (ITO pin) 	X	$X+Y \leq 3.5$	$\leq 1/10L$	not enter the inner border, the area touched Conduction potential is less than 1/4.	MIN	
	Y		$\leq 2/3W$			
	Z	$\leq t$	$\leq t$	$\leq t$		
	acceptable QTY'	1	2	2		

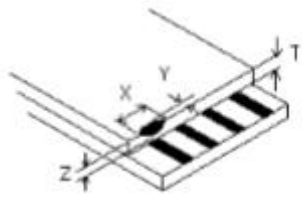
Item	Acceptable criteria				Defect grade
Sealing surface collapse (external collapse) 	(mm)	Under 5"	5"~7"	7"~10.1"	MIN
	X	≤1/10L	≤1/8L	≤1/8L	
	Y	invisible in VA area	invisible in VA area	invisible in VA area	
	Z	≤t	≤t	≤t	
	acceptable QTY'	1	2	2	
	For breakage between glass, if breakage cause conduction point or frame glue exposed more than 1/3: NG				
Convex glass, cutting defect, burrs, W, is ITO width	X	≤3.0	≤3.0	≤5.0	MIN
	Y	≤1/6W	≤1/5W	≤1/4H	
	Z	/	/	/	
	acceptable QTY'	1	1	2	
	The for the burrs, controlled according to the specifications of dimension tolerances				
fissure	non-directional and progressive cracks is not allowed. The fissure in the interior is NG and the fissure outward is acceptable(refer to the breakage criteria)				MAJ

Polarizer

Items	Description	Acceptance criteria	Defect grade
Slice oblique / serrated	Polarizer does not cover frame lines, or over tolerances	1. non-ITO pad area can be cut. 2. in general, A1, A2, A3 are controlled by tolerances for polarizer attaching, A0, A* controlled by vertical view until can observe black edge	MIN
water wave	To observe wave water phenomenon on the polarizer surface against the light	Refer to sample	MIN

Items	Description	Acceptance criteria	Defect grade
The protective film is difficult to tear, fall off and tilt	/	1.for peel off tape, if 3 times can bring up protective film, it's qualified. 2. the protective film on LCD front can't be tilted, obvious dirt or polarizer dirt can't be allowed 3., the protection film tilting will affect COG/FOG crimping, all reject 4. do not allow the protective film to fall off	MIN
Polarizer is attached to the reverse	The angle is reversed and the bottom or surface is reversed	rejection	MAJ
contamination	polarizer contamination	obvious contamination is not allowed	MIN
Direction	the range of angle view, background difference	Refer to the sample and keep in line with the same batch	MIN
bubble、concave-convex dot	There is air or bubbles caused by ink between polarizer and glass	for concave-convex dot,need to refer to sample	MIN

Other inspection items

Items	Description	Acceptance criteria	Defect grade
Rainbow	1pcs product with two or more colors	refer to sample	MIN
Leakage	Vacuum bubble, sealing is not full, liquid crystal is not filled, etc.	NG	MAJ
Protective film	There is no protective film on the polarizer, and obvious contamination on the surface is not allowed	NG	MIN
PIN part no and spec	the part no., specifications, length, span, angle, shape for PIN foot should be consistent with drawing	NG	MAJ

Items	Description	Acceptance criteria	Defect grade
Appearance	The PIN QTY' can't match, poor contact; sealed and UV glue on ITO is not completely cured, without sealing glue.	NG	MAJ
	PIN glue leakage,glue breakage,glue exceeds LCD,glue exceeds polarizer,If customer request special, the amount of glue should be judged as a serious defect	NG	MIN
	there is glue on PIN , PIN loose, deformed, skewed, and oxidized	NG	MIN
Peel-off tape	Missing attach, wrong position, crooked, peel off tape can not peel off protective film	NG	MIN
Identification and marking	already requested add Identification and marking on protection film or LCD footstep	The content is consistent with the requirement	MIN
		If the code can be identified at once, it is judged to be qualified	
Surface silk printing	After make silk printing, attach polarizer on LCD surface,observe there are Linear bubble phenomenon	refer to sample	MIN
PIN position	<p>f=PIN 错位宽度 shift width , w=ITO pad 宽度 width</p>	PIN crooked : $a \leq 1/3w$, $\psi \leq \pm 5^\circ$	MIN

Back-light

NO.	Items	Description	Acceptance criteria	Defect grade
8.2.12	LED no display,wrong color	LED no display, the color is not consistent with the sample or specifications	NG	MAJ
8.2.13	color difference	it's different with sample when display,and also different with drawing after measuring	NG	MIN

NO.	Items	Description	Acceptance criteria	Defect grade
8.2.14	Luminance difference	the luminance is different with sample when display and different with drawing also after measuring	If the deviation of the specifications is not indicated on the drawings, it shall be controlled according to the range of $\pm 15\%$ of the brightness for sample	MIN
8.2.15	Nonuniform	the uniformity is different with spec when display	if it's out of spec, reject, the uniformity that don't request on drawing should controlled as more than 75%	MIN
8.2.16	Scratch	it happen contamination .scratch ,dot and line defect when display	Refer to dot and line standard	MIN
8.2.17	Flicker	flicker phenomenon can't be allowed when display	NG	MAJ
8.2.18	B/L perk	PCB B/L must be very close to attach with PCB B/L	Backlight tilt no more than 0.5mm is allowed	MIN
8.2.19	Components taken off	the components on light guide is taken off	NG	MAJ
8.2.20	Date code	The code is inconsistent with the sample or drawing	NG	MIN

PCB/PCBA

NO.	Items	Description	Acceptance criteria	Defect grade
8.2.21	Glue sealing defect	<p>1) there is a bonding line in the round white mark, the circuit is exposed or the soldering plate is exposed more than 1 places;</p> <p>2) the height of sealing glue exceeds the requirement of spec; (no special requirement is controlled by 1.5mm)</p> <p>3) the sealing glue shall be in the white mark, the maximum shall not exceed the mark radius outside 2mm;</p> <p>4) there is obvious linear traces on the glue surface, and the pinholes penetrate through the wafers;</p> <p>5) the needle hole diameter of the glue surface >0.25mm and has extra objects;</p> <p>6) glue permeates to the opposite side of PCB</p>	reject	MIN

NO.	Items	Description	Acceptance criteria	Defect grade
8.2.22	PCB appearance	1) the surface of gold plate is oxidized or with dirt 2) gold is not golden, bright 2)there is bubbles after reflow soldering 3) warping and perking 4) green pitting, oxidation, corrosion	reject	MIN
		Green oil is faded,scratch or expose copper	Green oil pen repair. The diameter is 1.3mm on the line, and the diameter on the non-line is 2.6mm, allowing 10 places.	
		Glue area with glue	diameter≤2.0mm,2pcs allowed	
		Silk color,oil color,silk content,silk form	样品 sample	MIN
8.2.23	Components error or missing	The components on the PCBA is not consistent with BOM. The direction is wrong and the polarity is the opposite	NG	MAJ
8.2.24	Part no	part no or version is different with spec	拒收 reject	MAJ

SMT/SOLDERING

NO.	Items	Description	Acceptance criteria	Defect grade
8.2.25	Soldering defect	1)cold welding, false welding, missing welding , cracking of tin, tin is not dissolved etc.; 2) non welding area with tin ball or tin slag	NG	MAJ
8.2.26	DIP device	DIP devices, buttons, connectors and other devices are floating high and skew	NG	MIN
8.2.27	The shape of soldering point	The soldering point shall be recessed and shall be not allowed excess solder and inadequate tin and tin tip etc.	acceptable	MIN

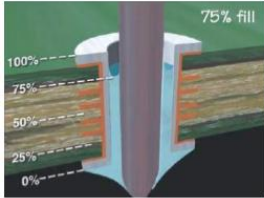
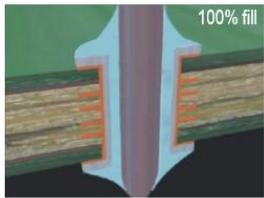
NO.	Items	Description	Acceptance criteria	Defect grade
8.2.28	Components foot exposed	for the plug type welding device, after soldering, cut off the foot	The height should be controlled in 0.5mm~2.0mm, cannot hurt the tin ball surface and excess welding cause device foot disappear	MIN
NO.	Items	Description	Acceptance criteria	Defect grade
8.2.29	The tin on the soldering vias is not reasonable	Metal soldering vias, solder joints, minimum tin penetration shall not exceed 25% of the plate thickness (i.e., the tin content is not less than 75% of the plate thickness as picture 1); the required pore size of the particular product shall be 100% filled, as shown in Figure 2   图 1 图 2	general, the tin content is not less than 75% of the plate thickness, and the special requirement is that the product exceeds 100% of the tin content	MIN
8.2.30	Appearance defect	The residual rosin is yellowish brown or charred	NG	MIN
8.2.31	Welding pinhole	happen spot Blowhole during welding process	$D \leq 0.2\text{mm}$, 1pcs allowed	MIN

Hot seal

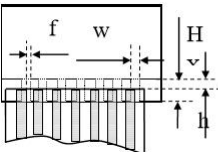
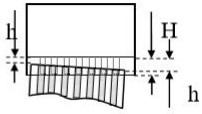
NO.	Items	Description	Acceptance criteria	Defect grade
8.2.32	part no and spec	Specifications for Zebra paper, FPC, etc.	Refer to the BOM sheet or drawings	MAJ
8.2.33	dimension and position	The size of heat pressing material should be within the range of drawing specification  	$f \leq 1/3W, h \leq 1/4H$, And meet the drawing size requirements	MIN

NO.	Items	Description	Acceptance criteria	Defect grade
8.2.34	objects happened during heat pressing	The foreign objects in the heat pressing area, and it is not in the open position ,can not cause short circuit; the foreign objects is smaller than the 50% pressing area	acceptable	MIN
8.2.35	fold trail	FPC or zebra paper fold to damage is not allowed	NG	MIN
8.2.36	FPC 外观	scratches, breakage, gold plate oxidized, stains	refer to sample	MIN
8.2.37	burrs	FPC with convex or concave in the edge	不伤及线路情况下 ≤2.0mm 控制 In the case without damaging the circuit controlled as ≤2.0mm	MIN

Connector and other parts

NO.	Items	Description	Acceptance criteria	Defect grade
8.2.38	part no/spec	The part no / specification must meet BOM list and design requirements, and the position shall be within the drawing specification	acceptable	MAJ
8.2.39	position	Welding reverse	NG	MAJ
8.2.40	order	The order of the first PIN and the PIN shall be consistent with the specifications of the product drawings	acceptable	MIN
8.2.41	contamination	External device and PIN foot are stained with solder flux, and the sealing glue shall not be attached to the PIN end of the connector	NG	MIN
8.2.42	PIN out of shape	<p>PIN connector, PIN bending, skew phenomenon</p>	<p>1) Pin out of shape is no more than 1/3 PIN thickness (if with socket, must guarantee connection well), can't allow PIN bent and bottom layer leakage</p> <p>2) PIN shift, $a \leq w/3$, $\psi \leq 5^\circ$, don't affect assembly, acceptable</p>	MIN

NO.	Items	Description	Acceptance criteria	Defect grade
8.2.43	PIN oxidation	PIN oxidation	NG	MIN
8.2.44	The via hole are blocked	Plug type connectors are not allowed to have a hole to plug the deformation phenomenon; with the latch of the lock should be able to tie the external connector lock (the matching pin to ensure that the matching plug and lock good)	NG	MIN
8.2.45	others	Other additional parts shall be consistent with drawings and technical requirements	if not affect function,pass	MIN

LCM APPEARANCE

NO.	Items	Description	Acceptance criteria	Defect grade
8.2.46	the appearance of connect or material	FPC, gold plate or zebra paper, the FPC end that connect with LCD or PIN exposed copper or leaking substrate; There are breakage, stain, or FPC, FFC, COF, zebra paper and other peripheral materials already fold to almost damaged (except original design); FPC, PCB gold plate with a sticky tin greater than 2/3PIN wide; FPC, FFC and other material stab, fold trail exceeds limited sample	NG	MIN
8.2.47	补强带不良	The adhesive tape must be completely covered and the protect circuits (such as zebra paper, FFC, FPC, etc.) can't exceed PIN area, and the black tape at the IC position shall be able to effectively shade the IC position	acceptable	MIN
8.2.48	reinforcing board or glue	After heat pressing, attach strong adhesive tape or play reinforcing glue according to technical specifications to protect all circuits, missing attachment is not allowed and must keep surface flat	acceptable	MIN
8.2.49	appearance stain	the labels or marks of rework product are not clean well, obvious stains (dust, finger prints), residual glue, etc.	In general, the batch of stains can not be acceptable normally	MIN



SHEN ZHEN JICTECHLCD CO., LTD

NO.	Items	Description	Acceptance criteria	Defect grade
8.2.50	assembly objects	the contamination(like dot or line) caused by B/L or diffusion	refer to dot/line standard	MIN
8.2.51	three proof pain	For the products that need three proof paint, the painting position must be correct, the pin and the test position, the gold plate can not be painted, the special location can not be exposed, and the thickness meets the design requirements	NG	MIN
8.2.52	product identification	part no and batch No (including Stickers / silk screen / inkjet) should be consistent with the requirements of the document, not blurred, leakage, paste, leak spray, bar code scanning defect	NG	MIN
8.2.53	Component identification	The component mark is not clear, the measurement value is consistent with the document request	allowed	MIN
8.2.54	Breakage of electronic components	components with hiatus or broken	NG	MAJ
8.2.55	assembly position	after assembly,upper and bottom 、 left and right of LCD shift and overall shift	refer to drawing and sample	MIN
8.2.56	mixed materials	The same batch of products mixed with different part no	NG	MAJ
8.2.57	TP assembly objects	there is TP assembly objects like fog shape	if it's invisible when display,pass it,others refer to dot/line standard	MIN
8.2.58	Socket or pin skew	upper and bottom 、 left and right shift	refer to drawing tolerance or sample	MIN
8.2.59	glue sealing defect	PIN glue exceeds polarizer 2) IC bonding glue with the hole that inner circuit or IC can be visible	NG	MIN

NO.	Items	Description	Acceptance criteria	Defect grade
8.2.60	overall structure	The overall mechanism assembly must be consistent with the assembly drawings	1) assembly skew, shift, (light guide LCD, TP, etc.), NG 2) bezel out of shape need to refer to limit sample	MIN
8.2.61	PIN heated to injure	In the process of welding ,pin is heated to injure	if it cause PIN not in a line, reject	MIN

PACKAGING

NO.	Items	Description	Acceptance criteria	Defect grade
8.2.62	Identification error	the par no on the label, order number, date code is not consistent with each other	NG	MAJ
8.2.63	shortage	The QTY' of identification is not consistent with actual QTY'	NG	MAJ
8.2.64	Packag e safety compliance	Packing meets ocean transportation requirements, anti-static, moisture-proof and so on	NG	MAJ

Others

If there are items that not be stipulated and concessions to release, subject to the agreement and the limit of the sample

9 PRECAUTION FOR USE OF LCD MODULE

9.1. Handling Precautions

- 1) The display panel is made of glass. Do not subject it to a mechanical shock by dropping it from a high place, etc.
- 2) If the display panel is damaged and the liquid crystal substance inside it leaks out ,be sure not to get any in your mouth, if the substance comes into contact with your skin or clothes, promptly wash it off using soap and water.
- 3) Do not apply excessive force to the display surface or the adjoining areas since this may cause the color tone to vary.
- 4) The polarizer covering the display surface of the LCD module is soft and easily scratched. Handle this polarizer carefully. 5) If the display surface is contaminated, breathe on the surface and gently wipe it with

a soft dry cloth. If still not completely clear, moisten cloth with one of the following solvents:

- Isopropyl alcohol 异丙醇
- Ethyl alcohol 酒精

Solvents other than those mentioned above may damage the polarizer.

Especially, do not use the following:

- Water 水
- Ketone 芳香剂

6) Do not attempt to disassemble or process the LCD module.

9.2. Assembling Precautions

- 1) When mounting the LCD module make sure that it is free of twisting, warping, and distortion. Distortion has great influence upon display quality. Also keep the stiffness enough regarding the outer case.
- 2) Please handle the LCD module by its side.
- 3) NC terminal should be open. Do not connect anything.
- 4) If the logic circuit power is OFF, do not apply the input signals.
- 5) To prevent destruction of the elements by static electricity, be careful to maintain an optimum work environment.
 - Be sure to ground the body when handling the LCD module.
 - Tools required for assembly, such as soldering irons, must be properly grounded.
 - To reduce the amount of static electricity generated, do not conduct assembly and other work under dry conditions.
 - The LCD module is coated with a film to protect the display surface. Exercise care when peeling off this protective film since static electricity may be generated.

LCD

6) Be careful when treating the glass panel because it has very sharpened edge.

9.3. Storage Precautions

- 1) When storing the LCD module, avoid exposure to direct sunlight or to the light of fluorescent lamps and high temperature/high humidity. Whenever possible, the LCD module should be stored in the same conditions in which they were shipped from our company.
- 2) Exercise care to minimize corrosion of the electrode. Corrosion of the electrodes is accelerated by water droplets or a current flow in a high-humidity environment.

9.4. Design Precautions

The absolute maximum ratings represent the rated value beyond which LCD module can not

- 1) exceed. When the LCD modules are used in excess of this rated value, their operation characteristics may be adversely affected.
- 2) To prevent the occurrence of erroneous operation caused by noise, attention must be paid to satisfy VIL, VIH specification values including taking the precaution of using signal cables that are short.
- 3) The LCD exhibits temperature dependency characteristics. Since recognition of the display becomes difficult when the LCD is used outside its designated operating temperature range, be sure to use the

LCD within this range. Also keep in mind that the LCD driving voltage levels necessary for clear displays will vary according to temperature.

- 4) We recommended that power supply lines (VDD) have over-current protection line. (Fuse etc. Recommend Value:0.5A)
- 5) Sufficiently notice the mutual noise interference occurred by peripheral devices.
- 6) To cope with EMI, take measures basically on outputting side.
- 7) When installing an LCD module, fasten it at the LCD panel.
- 8) The display panel is made of general float glass which is not guaranteed for strength. So please consider about following.
 - Do not subject panel to a mechanical shock by dropping directly.
 - Do not let case to touch to panel directly.

Others

- 1) Liquid crystal solidifies under low temperature (below the storage temperature range) leading to defective orientation or the generation of air bubbles (black or white). Air bubbles may also be generated if the LCD module is subjected to a strong shock at a low temperature.
- 2) If the LCD modules have been operating for a long time showing the same display patterns, the display patterns may remain on the screen as ghost images and a slight contrast irregularity may also appear. A normal operating status can be regained by suspending use for some time. It should be noted that this phenomenon does not adversely affect performance reliability.
- 3) To minimize the performance degradation of the LCD module's resulting from destruction caused by static electricity, etc., exercise care to avoid touching the following section when handling this module: LCD's Terminal electrode sections.
- 4) Optimum voltage to obtain best contrast value depending on products. Therefore voltage adjustment with electric volume is required in each display.
- 5) Precaution for disposal of LCD module. When disposal of LCD module, ask specialization company of industrial waste which is permitted by the government. When burn up LCD module, obey the law of environmental hygienics.